

## TL 600T

- The coupling devices TL\* are used to adapt the input circuits of the insulation monitoring device to a higher operating voltage than the operating voltage of the IMD directly.
- The coupling units are connected between IT power supply system and insulation monitoring device.

Type		TL 600T
Rated operating AC voltage	$U_N$	600 V
Maximum continuous operating voltage AC	$U_C$	720 V
Designed for insulation monitoring device		HIS71, HIG95, HIG93, HIG91, HIG92, HIG94
Maximal operating current AC	$I_C$	< 3 x 0,1 mA
Internal resistance	$R_{IN}$	3 x 12,7 k $\Omega$
Internal inductance	$L_{IN}$	3 x 330 H
Offset for insulation monitoring device	$R_{tl\ ext}$	4.4 k $\Omega$
Housing material		Polyamid PA6, UL94 V-0
Degree of protection		IP20
Operating temperature	$\theta$	-25 ÷ 55 °C
Recommended cross-section of connected conductors	S	1.5 mm <sup>2</sup>
Tightening moment		0,2 Nm
Installation		On DIN rail 35 mm
Modular width		2 TE
Operating position		Any
Operation type		Permanent
Lifetime		> 100 000 h
Use for traction		Yes
<b>Designed according to standards</b>		
Insulation coordination for equipment within low-voltage systems		IEC 60664-1:2007
Safety of power transformers, power supplies, reactors and similar		IEC 61558-1:2005
<b>Ordering, packaging and additional data</b>		
Mass	m	310 g
Mass (including the packaging)	m	324 g
Packaging dimensions (H x W x D)		45 x 102 x 74 mm
Packaging value	V	0.34 dm <sup>3</sup>
Customs tariff no.		90303370
EAN code		8590681320648
<b>Art. number</b>		<b>70 516</b>



The link in the QR code leads to the online presentation of the TL 600T. There, in addition to the always up-to-date data sheet, you will also find all diagrams and drawings, declarations of conformity, or 2D or 3D models and other necessary materials. For more information, visit [www.hakel.com](http://www.hakel.com)



**Application wiring diagram (installation)**

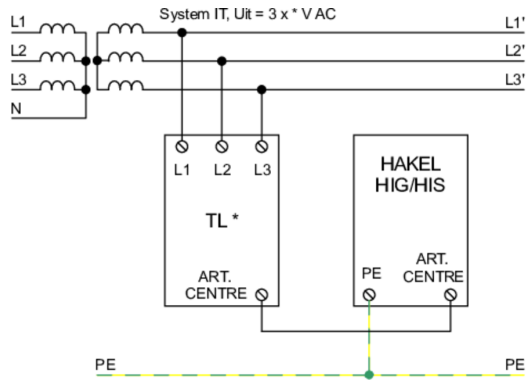

**Internal diagram**

